

Driver's Guide

for the

TXB50



battery powered amplifier

with **DSP** and the new

rugged lightweight High-Impact

enclosure!



CRATE

CONGRATULATIONS!

You are now the proud owner of the Crate TXB50 battery powered amplifier with Digital Signal Processing. At last, you can take your music with you and have great tone on the road. Not only is the TXB50 compact and portable, it also features a four band rotary eq, a switchable contour control and the incredible sound that has made Crate a household name among musicians. The high tech polymer enclosure makes the amplifier lighter and even more portable!

Like all Crate products, your TXB50 is designed by musicians and built using the finest components available. Each unit is rigorously tested by skilled technicians and musicians to ensure that your amplifier is the best it can be!

In order to get the most out of your new amplifier, we strongly urge you to go over the information contained in this manual before you begin playing.

Thanks for choosing **CRATE**.



CONTENTS:

| | |
|--------------------------------|------------|
| Features | 3 |
| About the Power Supply | 4,5 |
| The Front Panel | 6,7 |
| The Rear Panel | 8 |
| About the Insert Jack | 8 |
| Suggested Setups | 9,10 |
| System Block Diagram | 11 |
| Technical Specifications | back cover |

| | | |
|---|--|--|
|  CAUTION RISK OF ELECTRIC SHOCK DO NOT OPEN |  PRECAUCION RIESGO DE CORRIENTAZO NO ABRA |  ATTENTION RISQUE D'ELECTROCUTION NE PAS OUVRIR |
| WARNING: TO REDUCE THE RISK OF FIRE OR ELECTRIC SHOCK, DO NOT EXPOSE THIS APPARATUS TO RAIN OR MOISTURE. TO REDUCE THE RISK OF ELECTRIC SHOCK, DO NOT REMOVE COVER. NO USER-SERVICEABLE PARTS INSIDE. REFER SERVICING TO QUALIFIED SERVICE PERSONNEL. | PRECAUCION: PARA REDUCIR EL RIESGO DE INCENDIOS O DESCARGAS ELECTRICAS, NO PERMITA QUE ESTE APARATO QUEDE EXPUESTO A LA LLUVIA O LA HUMEDAD. PARA DISMINUIR EL RIESGO DE CORRIENTAZO, NO ABRA LA CUBIERTA. NO HAY PIEZAS ADENTRO QUE EL USUARIO PUEDA REPARAR DE JE TODO MANTENIMIENTO A LOS TECNICOS CALIFICADOS. | ATTENTION: PROTEGEZ CET APPAREIL DE LA PLUIE ET DE L'HUMIDITE AFIN D'EVITER TOUT RISQUE D'INCENDIE OU D'ELECTROCUTION. POUR REDUIRE D'ELECTROCUTION NE PAS ENLEVER LE COUVERCLE. AUCUNE PIECE INTERNE N'EST REPARABLE PAR L'UTILISATEUR. POUR TOUTE REPARATION, S'ADRESSER A UN TECHNICIEN QUALIFIE. |

IMPORTANT SAFETY INSTRUCTIONS

- READ, FOLLOW, HEED, AND KEEP ALL INSTRUCTIONS AND WARNINGS.
- DO NOT OPERATE NEAR ANY HEAT SOURCE AND DO NOT BLOCK ANY VENTILATION OPENINGS ON THIS APPARATUS. FOR PROPER OPERATION, THIS UNIT REQUIRES 3" (75mm) OF WELL VENTILATED SPACE AROUND HEATSINKS AND OTHER AIR FLOW PROVISIONS IN THE CABINET.
- DO NOT USE THIS APPARATUS NEAR SPLASHING, FALLING, SPRAYING, OR STANDING LIQUIDS.
- CLEAN ONLY WITH LINT-FREE DAMP CLOTH AND DO NOT USE CLEANING AGENTS.
- ONLY CONNECT POWER CORD TO A POLARIZED, SAFETY GROUNDED OUTLET WIRED TO CURRENT ELECTRICAL CODES AND COMPATIBLE WITH VOLTAGE, POWER, AND FREQUENCY REQUIREMENTS STATED ON THE REAR PANEL OF THE APPARATUS.
- PROTECT THE POWER CORD FROM DAMAGE DUE TO BEING WALKED ON, PINCHED, OR STRAINED.
- UNPLUG THE APPARATUS DURING LIGHTNING STORMS OR WHEN UNUSED FOR LONG PERIODS OF TIME.
- ONLY USE ATTACHMENTS, ACCESSORIES, STANDS, OR BRACKETS SPECIFIED BY THE MANUFACTURER FOR SAFE OPERATION AND TO AVOID INJURY.
- THIS APPARATUS DOES NOT OPERATE NORMALLY AND REQUIRES SERVICE WITH ANY PHYSICAL DAMAGE FROM IMPACT OR ANY EXPOSURE TO MOISTURE.
- SERVICE MUST BE PERFORMED BY QUALIFIED PERSONNEL.
- OUR AMPLIFIERS ARE CAPABLE OF PRODUCING HIGH SOUND PRESSURE LEVELS. CONTINUED EXPOSURE TO HIGH SOUND PRESSURE LEVELS CAN CAUSE PERMANENT HEARING IMPAIRMENT OR LOSS. USER CAUTION IS ADVISED AND EAR PROTECTION IS RECOMMENDED IF UNIT IS OPERATED AT HIGH VOLUME.

| | | | | |
|--------------------------------------|---|------------------------|---|--|
| EXPLANATION OF GRAPHICAL SYMBOLS: |  | "DANGEROUS VOLTAGE" |  | "IT IS NECESSARY FOR THE USER TO REFER TO THE INSTRUCTION MANUAL" |
| EXPLICACION DE SIMBOLOS GRAFICOS: | | "VOLTAJE PELIGROSO" | | "ES NECESARIO QUE EL USUARIO SE REFIERA AL MANUAL DE INSTRUCCIONES." |
| EXPLICATION DES SYMBOLES GRAPHIQUES: | | "DANGER HAUTE TENSION" | | "REFERREZ-VOUS AU MANUAL D'UTILISATION" |

FEATURES:

- Four band rotary equalizer
- Switchable Contour control
- Crate's Digital Signal Processing (DSP)
- Insert jack for connecting external effects
- CD Inputs for connecting background music
- Headphones jack for silent operation
- Internal rechargeable power supply for at least 8 hours of normal playing time, 2 hours at full output – fully recharges within 6 hours (when battery is fully discharged; shorter if partially charged)
- Two-color battery status LED – red indicates low battery, yellow indicates battery okay
- Can also be powered by an AC wall adapter or by a 12 volt automotive adapter (see page 5)
- Tuned port cabinet for extended bass response
- Durable black molded polymer enclosure
- Rubber feet on three sides – for positioning as a low angle monitor, a high angle monitor or as an upright speaker (see below)
- Provisions for 1-1/2" diameter stand mounting (installation kit not included)

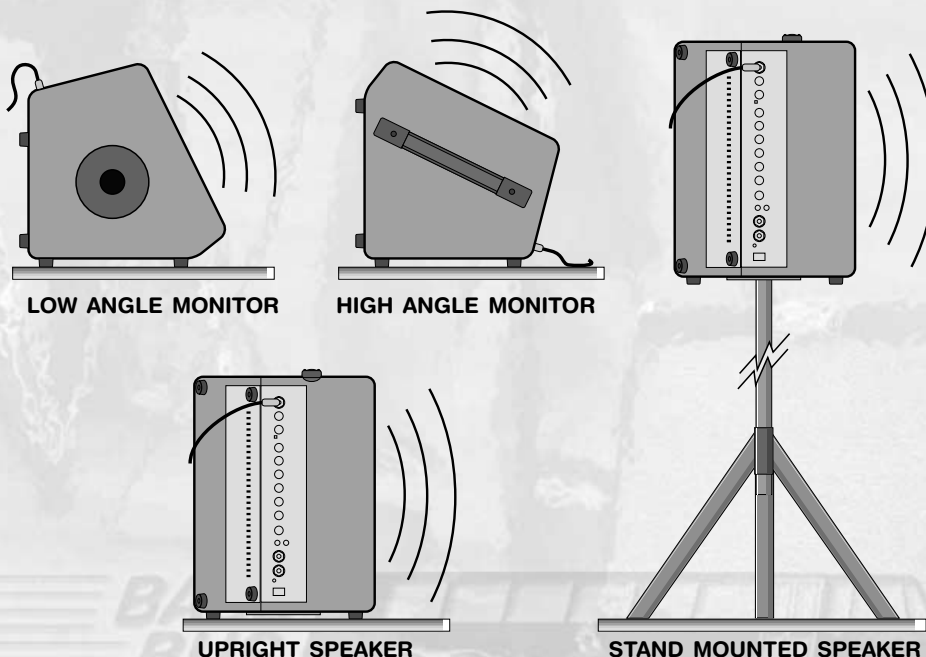

ABOUT THE POWER SUPPLY:

The TXB50 uses a sealed lead-acid 12-volt battery as its internal power source. Unlike ni-cad batteries, this battery has no “memory” – it can be fully recharged at any time, without damage to the battery.

When fully charged, the LED next to the power switch will illuminate yellow with the switch at the on position. The LED will change to red when the battery is low and needs recharging. When this happens, turn the amp off, connect the 15-volt charger to the charger jack and plug it in to an AC outlet. The LED near the charger jack will illuminate red while the amp is charging and goes out when the amp is fully charged. The battery fully recharges within 6 hours, providing up to 8 hours of use at low levels, about 4 hours of use at moderate levels, and about 2 hours of use at continuous full power (sine wave). The battery is rated for up to 1000 charging cycles. (The charger can also function as an AC power supply.)

The battery inside the TXB50 must be fully charged before operating the amplifier for the first time. The amplifier leaves our factory with a fully charged battery. However, the battery may lose some of its charge in transit.

NOTE: If the battery is drained too low, the Power LED will go out. This indicates an exhausted battery – one which may not take a charge. If this happens, turn the amp off, connect the 15-volt charger to the charger jack and plug it in. If the Charger LED (see #17, page 8) doesn't illuminate, the battery might be beyond recharging. (The TXB50 uses a “smart” charging circuit and will not allow you to charge a defective battery.) If the battery is serviceable, the LED will illuminate once the battery reaches 10 volts – leave the charger plugged in and let the battery fully recharge. If the LED never illuminates, the battery may need replacing. Contact Crate's service department:

SLM Electronics
1901 Congressional Drive
St. Louis, MO 63146
1-800-738-PARTS (7563)

To avoid damaging the amplifier, do not connect the 15VAC charger to the amplifier's 12VDC Cigarette Lighter Adapter jack.

CAUTION! The TXB50 contains a sealed, rechargeable, lead-acid battery. Dispose of battery properly. Improper disposal of the battery or replacement with any other type may cause leakage, explosion, and/or injury. Refer also to the warranty card.

ABOUT THE POWER SUPPLY (continued):

The TXB50 may also be powered by using a 12-volt automotive cigarette lighter adapter, available at most electronic supply stores. Make certain that the polarity on the adapter matches what is shown below.



Connect the small round end of the adapter to the 12VDC Automobile adapter jack (#18, page 8), then connect the other end of the adapter into the vehicle's cigarette lighter socket. (In some vehicles, the ignition switch must be in the "on" or "accessory" position to have power at the socket.) **NEVER PLUG THE 15VDC CHARGER INTO THE AMPLIFIER'S 12VDC LIGHTER PLUG!**

When using the DC cigarette lighter adapter, the vehicle's battery will keep the amp charged to its own voltage level – if the battery has a 13.5 volt charge, the amp will charge up to 13.5 volts; if the battery is low and only has a 10-volt charge, the amp will discharge down to 10 volts.

Declaration Of Conformity

#26, Effective 01-01-2001

| | |
|---------------------------------|--|
| Manufacturer's Name: | SLM Electronics |
| Production Facility: | 11880 Borman Drive, St. Louis, MO 63146, USA |
| Production Facility: | 700 Hwy 202 W, Yellville, AR 72687, USA |
| Shipping Facility: | 1400 Ferguson Ave., St. Louis, MO 63133, USA |
| Office Facility: | 1400 Ferguson Ave., St. Louis, MO 63133, USA |
| Product Type: | Audio Amplifier |
| Complies with Standards: | |
| LVD: | 92/31/EEC, 93/68/EEC, & 73/23/EWG |
| Safety: | EN60065 |
| EMC: | EN55013, EN55020, EN55022, EN61000-3-2, & EN61000-3-3 |

Supplementary information provided by your local Sales & Services Office or:

SLM Electronics - R & D Engineering
1901 Congressional Drive, St Louis, MO 63146, USA
Tel.: 314-569-0141, Fax: 314-569-0175

THE FRONT PANEL:

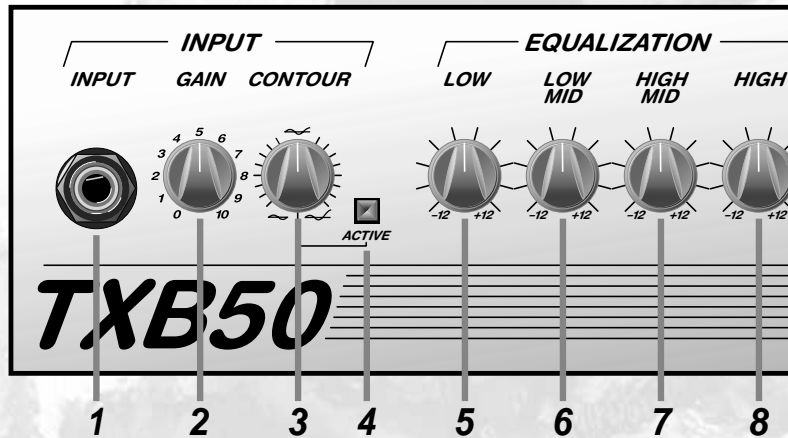

1. **INPUT:** Connect an active or passive instrument here by means of a shielded signal cable terminated with a 1/4" connector.

2. **GAIN:** Use this control to adjust the input signal level for the best signal to noise ratio without distortion.

3. **CONTOUR:** This control is only active when the Contour Active switch (#4) is depressed. Use this control to vary the position of the contour effect. This control gives you a wide variety of tone variations, from a studio "V"-shaped tone to a more "live," more present sound.

4. **CONTOUR ACTIVE:** This switch, when depressed, activates the Contour control (#3).

5. **LOW:** Use this control to adjust the low frequency level of the amplifier. This control provides a 19dB range of cut or boost at 60Hz.

6. **LOW MID:** Use this control to adjust the lower-midrange frequency level of the amplifier. This control provides a 25dB range of cut or boost at 200Hz.

7. **HIGH MID:** Use this control to adjust the upper-midrange frequency level of the amplifier. This control provides a 16dB range of cut or boost at 1kHz.

8. **HIGH:** Use this control to adjust the high frequency level of the amplifier. This control provides a 28dB range of cut or boost at 10kHz.



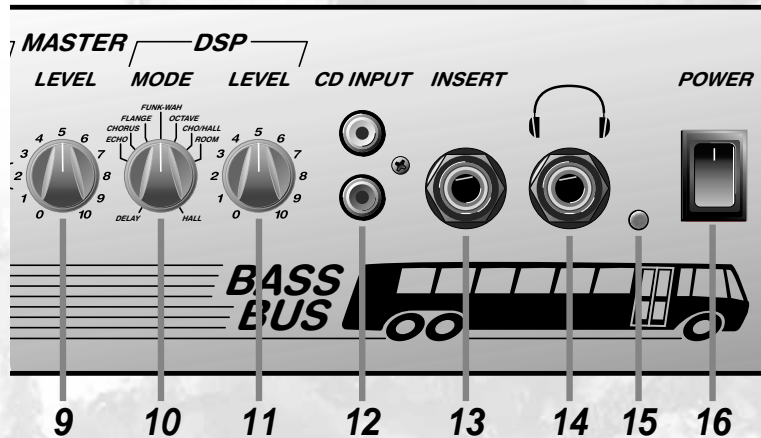

9. MASTER LEVEL: Use this control to adjust the overall output of the amplifier.

10. DSP MODE: Use this control to select the type of Digital Signal Processing (DSP) effect applied to the signal. The effects are as follows:

DELAY: Slapback delay effect

ECHO: Long delay effect with regeneration

CHORUS: Chorus effect

FLANGE: Light flange effect

FUNK-WAH: Touch-sensitive wah-wah effect

OCTAVE: Adds secondary note one octave lower than original note

CHO/HALL: Chorus effect with large hall reverb

ROOM: Small room reverb effect

HALL: Large hall reverb effect

11. DSP LEVEL: Use this control to adjust the amount of DSP effect to be applied to the signal. In the fully counterclockwise position, no effect is applied. As you rotate the control clockwise the amount of effect increases.

12. CD INPUT: Use these jacks to connect the outputs of a CD player or tape player to the amplifier. The output of the CD or tape

player may need to be attenuated for a suitable mix with the input channels – see the notes on page 10.

13. INSERT: Use this jack to connect an external effects device to the amplifier, or as an input for a drum machine or other line level signal. This jack is wired as follows:

Tip = Line In (Return - from effect out)

Ring = Line Out (Send - to effect in)

Sleeve = ground

See page 8 for additional information.

14. HEADPHONES: Use this jack to connect a pair of stereo headphones for private practice sessions. The internal speakers are disconnected when headphones are used.

15. LED: When the power switch is on and the battery is fully charged, this LED illuminates yellow. The LED illuminates red when the battery needs recharging.

16. POWER: Use this switch to turn the amplifier on (top of the switch depressed) or off (bottom of switch depressed).

THE REAR PANEL:

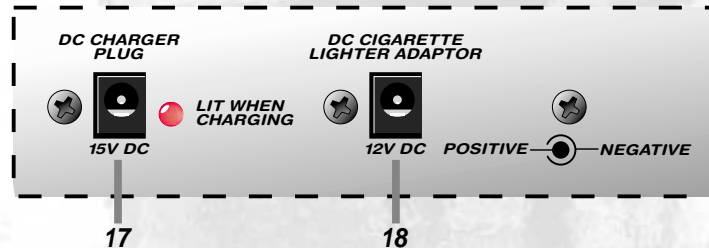

17. DC CHARGER PLUG, 15VDC: Plug the small round connector of the AC wall adapter into this jack to charge the internal battery. The LED next to the jack glows red when the amp is charging. See page 4 for additional information.

18. DC CIGARETTE LIGHTER ADAPTER, 12 VDC: Plug the small round connector of the optional 12-volt car adapter into this jack to play the amplifier from a vehicle, instead of the internal battery. NEVER connect the 15-volt charger to this jack! See page 4 for additional information.

ABOUT THE INSERT JACK:

The Insert jack (#13) lets you patch external effects into the amplifier just prior to its power amp stage, as shown below. Set the mix controls on the external effects units to “full effect” (100% wet).

The Insert jack is a parallel circuit, allowing the connection of another input to the amplifier without interrupting the signal from the Input jack. An attenuator or external level control may be needed whenever a line level signal is connected to the Insert jack.

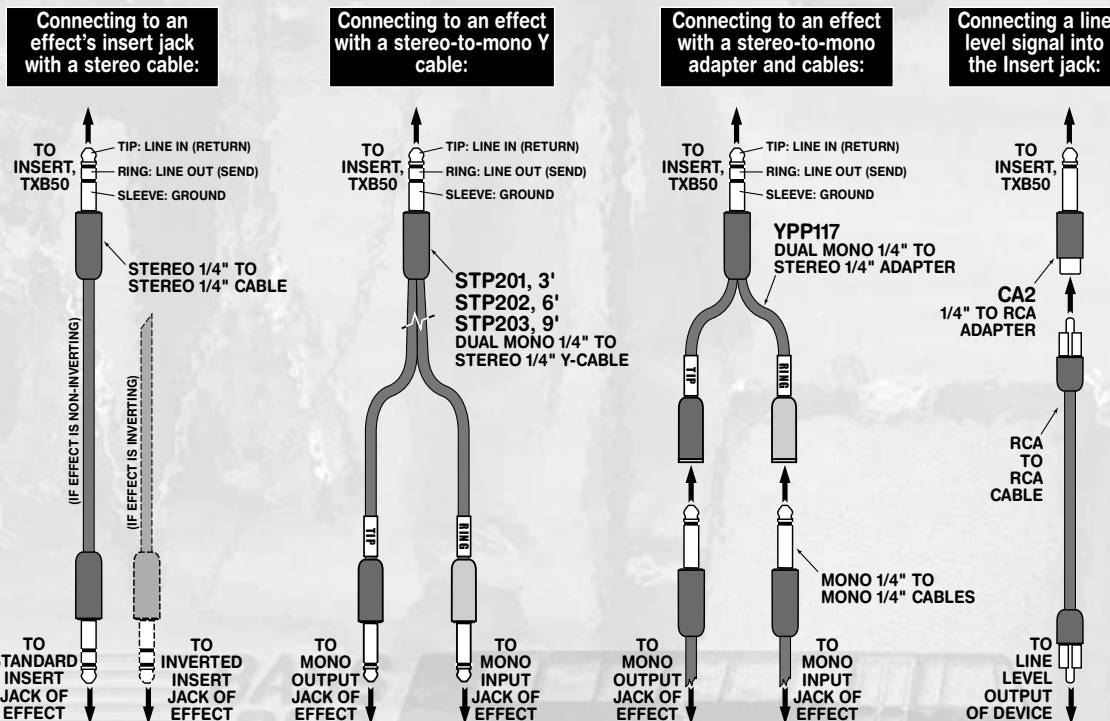

SUGGESTED SET-UPS:

The TXB50 can be used in a variety of different ways, some of which are shown below and on the following page. Use these ideas to fuel your imagination for the setup which best suits your needs.

Idea 1 – Play along, with external effects and backup: Connect an instrument (bass, guitar, keyboard) to the Input jack. (This high-Z input works with all types of pickups, from Piezo to active types.) Connect a tape player or CD player to the CD Input jacks. Connect the external effects device to the Insert jack using one of the methods shown on page 8. (Note that the external effect will be applied full strength to the instrument, as well as the CD inputs, so use with discretion.) A pair of stereo headphones may be connected to the Headphones jack for privacy.

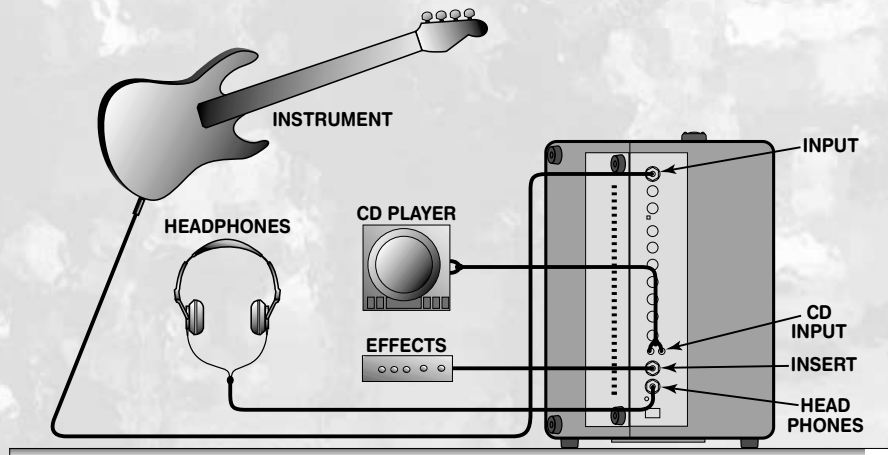

Idea 2 – Play along, version two: Connect an instrument to the Input jack. Connect a tape player or CD player to the CD Input jacks. (See the notes on page 10 for more detailed information.) Connect a drum machine to the Insert jack. Use a mono 1/4" connector - tip = signal +, sleeve = ground. (See page 8.)

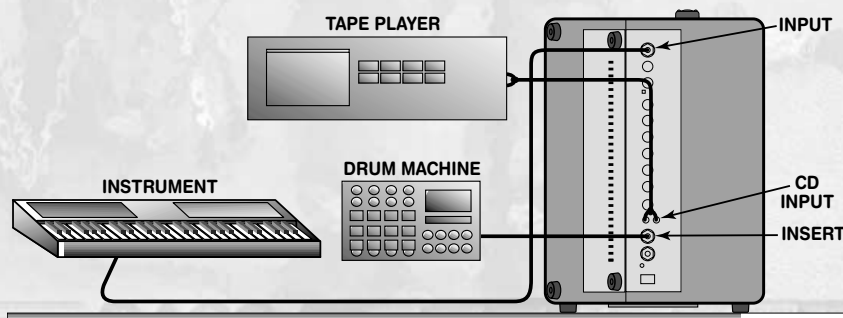

SUGGESTED SET-UPS (CONTINUED):

Idea 3 - Music Playback: Connect the outputs of a CD player or tape deck to the Input jack. (Use a dual RCA-to-mono 1/4" adapter as shown below.) Use the gain, eq and level controls to adjust the sound as desired.

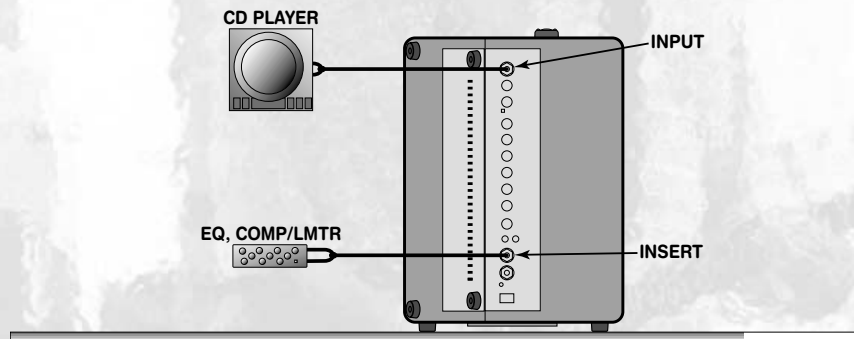

Notes:

- When a tape player or CD player is connected to the CD Input jacks, the output of the player may need to be adjusted by means of its output level control (if it has one), or by an external attenuator/preamp.
- A tape player or CD player may be connected to the Input channel instead of the CD Input jacks. This provides control of the gain and equalization of the signal, as well as the application of the DSP if desired. In this case, the left and right outputs of the tape or CD player must be summed as shown below to create a mono signal.

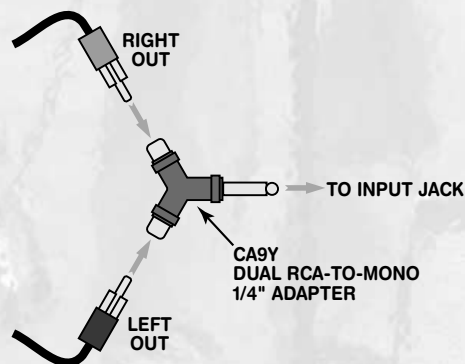

SYSTEM BLOCK DIAGRAM:

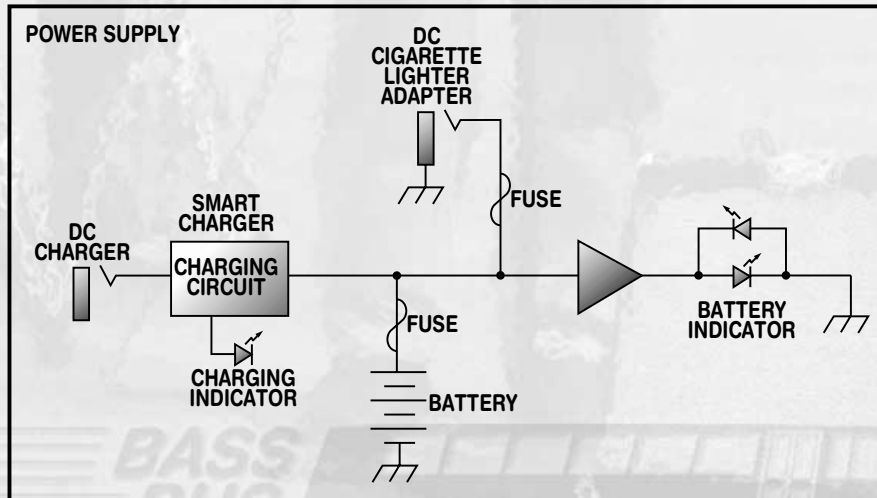
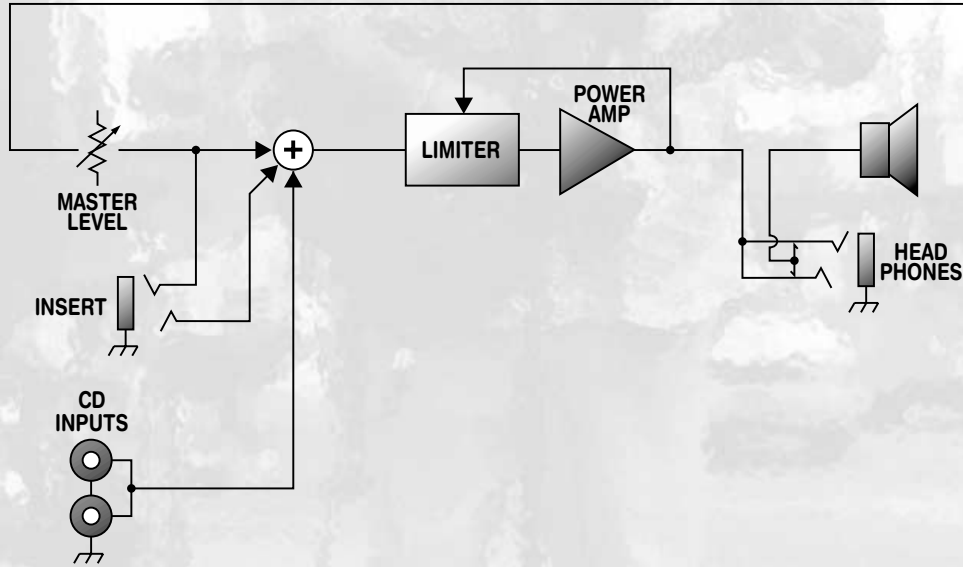
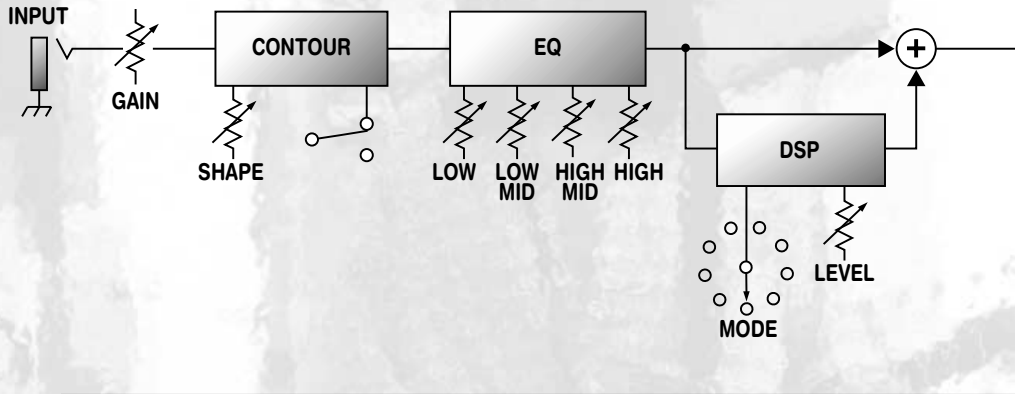

TECHNICAL SPECIFICATIONS

OUTPUT POWER RATING 50W RMS @ 10% THD, 4 ohms, 13.6VDC in

INPUT IMPEDANCE 220k ohm

MAXIMUM SIGNAL ACCEPTED 12V peak to peak

GAIN

| | |
|----------|------|
| Input | 52dB |
| CD Input | 23dB |
| Insert | 37dB |

SENSITIVITY

| | |
|----------------|-----------|
| Input | 25mV RMS |
| Line In Insert | 150mV RMS |

EQS

| | |
|----------|--------------------|
| Low | 19dB range @ 60Hz |
| Low Mid | 25dB range @ 200Hz |
| High Mid | 16dB range @ 1kHz |
| High | 28dB range @ 10kHz |

INSERT JACK

| | |
|--------|----------|
| Tip | Line In |
| Ring | Line Out |
| Sleeve | Ground |

SPEAKER Crate Custom Design 10", 4 ohm, 50 watt
1.0" voice coil, 30 oz magnet

POWER REQUIREMENTS Internal 12 volt DC power supply, 18VA

SIZE AND WEIGHT 18-1/2"W x 13-1/2"H x 12-1/2"D; 22 lbs.

The TXB50 is enclosed in a rugged, molded high tech polymer cabinet. Wipe the enclosure with a damp, lint-free cloth to remove dirt and road film. Never spray cleaning agents directly onto the enclosure. Do not use abrasive cleansers which will damage the finish.

Crate continually develops new products, as well as improves existing ones. For this reason, the specifications and information in this manual are subject to change without notice.

CRATE

www.crateamps.com

