



# ***BT25/BT50***

**BASS AMPLIFIER**



**USER'S GUIDE**

**Table Of Contents:**







Introduction . . . . .3

The Front Panel . . . . .4,5

Some Suggested Settings . . . . .6

System Block Diagram . . . . .7

Technical Specifications . . . . .back cover

 <p><b>CAUTION</b> RISK OF ELECTRIC SHOCK DO NOT OPEN</p> <p>! (Warning symbol)</p> <p><small>WARNING: TO REDUCE THE RISK OF FIRE OR ELECTRIC SHOCK, DO NOT EXPOSE THIS APPARATUS TO RAIN OR MOISTURE. TO REDUCE THE RISK OF ELECTRIC SHOCK, DO NOT REMOVE COVER. NO USER-SERVICEABLE PARTS INSIDE. REFER SERVICING TO QUALIFIED SERVICE PERSONNEL.</small></p>	 <p><b>PRECAUCION</b> RIESGO DE CORRIENTAZO NO ABRA</p> <p>! (Warning symbol)</p> <p><small>PRECAUCION: PARA REDUCIR EL RIESGO DE INCENDIOS O DESCARGAS ELECTRICAS, NO PERMITA QUE ESTE APARATO QUEDE EXPUESTO A LA LLUVIA O LA HUMEDAD. PARA DISMINUIR EL RIESGO DE CORRIENTAZO, NO ABRA LA CUBIERTA. NO HAY PIEZAS ADENTRO QUE EL USUARIO PUEDE REPARAR. DEJE TODO MANTENIMIENTO A LOS TECNICOS CALIFICADOS.</small></p>	 <p><b>ATTENTION</b> RISQUE D'ELECTROCUTION NE PAS OUVRIR</p> <p>! (Warning symbol)</p> <p><small>ATTENTION: PROTEGEZ CET APPAREIL DE LA PLUIE ET DE L'HUMIDITE AFIN D'EVITER TOUT RISQUE D'INCENDIE OU D'ELECTROCUTION. POUR REDUIRE D'ELECTROCUTION NE PAS ENLEVER LE COUVERCLE. AUCUNE PIECE INTERNE N'EST REPRABLE PAR L'UTILISATEUR. POUR TOUTE REPARATION, S'ADRESSEZ A UN TECHNICIEN QUALIFIE.</small></p>
<p><b>IMPORTANT SAFETY INSTRUCTIONS</b></p> <ul style="list-style-type: none"> <li>• READ, FOLLOW, HEED, AND KEEP ALL INSTRUCTIONS AND WARNINGS.</li> <li>• DO NOT OPERATE NEAR ANY HEAT SOURCE AND DO NOT BLOCK ANY VENTILATION OPENINGS ON THIS APPARATUS. FOR PROPER OPERATION, THIS UNIT REQUIRES 3" (75mm) OF WELL VENTILATED SPACE AROUND HEATSINKS AND OTHER AIR FLOW PROVISIONS IN THE CABINET.</li> <li>• DO NOT USE THIS APPARATUS NEAR SPLASHING, FALLING, SPRAYING, OR STANDING LIQUIDS.</li> <li>• CLEAN ONLY WITH LINT-FREE DAMP CLOTH AND DO NOT USE CLEANING AGENTS.</li> <li>• ONLY CONNECT POWER CORD TO A POLARIZED, SAFETY GROUNDED OUTLET WIRED TO CURRENT ELECTRICAL CODES AND COMPATIBLE WITH VOLTAGE, POWER, AND FREQUENCY REQUIREMENTS STATED ON THE REAR PANEL OF THE APPARATUS.</li> <li>• PROTECT THE POWER CORD FROM DAMAGE DUE TO BEING WALKED ON, PINCHED, OR STRAINED.</li> <li>• UNPLUG THE APPARATUS DURING LIGHTNING STORMS OR WHEN UNUSED FOR LONG PERIODS OF TIME.</li> <li>• ONLY USE ATTACHMENTS, ACCESSORIES, STANDS, OR BRACKETS SPECIFIED BY THE MANUFACTURER FOR SAFE OPERATION AND TO AVOID INJURY.</li> <li>• WARNING: TO REDUCE THE RISK OF ELECTRIC SHOCK OR FIRE, DO NOT EXPOSE THIS UNIT TO RAIN OR MOISTURE..</li> <li>• SERVICE MUST BE PERFORMED BY QUALIFIED PERSONNEL.</li> <li>• OUR AMPLIFIERS ARE CAPABLE OF PRODUCING HIGH SOUND PRESSURE LEVELS. CONTINUED EXPOSURE TO HIGH SOUND PRESSURE LEVELS CAN CAUSE PERMANENT HEARING IMPAIRMENT OR LOSS. USER CAUTION IS ADVISED AND EAR PROTECTION IS RECOMMENDED IF UNIT IS OPERATED AT HIGH VOLUME.</li> </ul>		
<p>EXPLANATION OF GRAPHICAL SYMBOLS:       = "DANGEROUS VOLTAGE"</p> <p>EXPLICACION DE SIMBOLOS GRAFICOS:       = "VOLTAJE PELIGROSO"</p> <p>EXPLICATION DES SYMBOLES GRAPHIQUES:       = "DANGER HAUTE TENSION"</p> <p style="text-align: right;">"IT IS NECESSARY FOR THE USER TO REFER TO THE INSTRUCTION MANUAL"</p> <p style="text-align: right;">"ES NECESARIO QUE EL USUARIO SE REFIERA AL MANUAL DE INSTRUCCIONES."</p> <p style="text-align: right;">"REFERREZ-VOUS AU MANUAL D'UTILISATION"</p>		

**Congratulations!**

You are now the proud owner of the compact but powerful Crate BT25/BT50 Bass Amplifier. The BT25/BT50 features two different channels: a distortion channel, featuring Crate's exclusive Shape control for quick and easy access to the tone you need, and a clean channel with a four-band rotary EQ. Another unique and valuable feature of this amplifier is the Octave control. This feature electronically creates a second signal that is one octave lower than the original signal. An active electronic tuner, conveniently located on top of the amplifier, allows you to get in tune and stay in tune "on the fly." Front panel jacks are provided for connecting a CD player and a pair of headphones, thereby optimizing your practice time.

Like all Crate products, your BT25/BT50 is designed by musicians and built using only the best components. Extensive testing at the hands (and ears) of skilled technicians and musicians insures you that this amplifier is the absolute best it can be.

In order to get the most out of your new bass amp, we urge you to check out the information in this manual before you begin playing.

And **thank you** for choosing Crate.

**Declaration Of Conformity**

#28, Effective 01-01-2001

**Manufacturer's Name:** SLM Electronics  
**Production Facility:** 1901 Congressional Drive, St. Louis, MO 63146, USA  
**Production Facility:** 700 Hwy 202 W, Yellville, AR 72687, USA  
**Shipping Facility:** 1400 Ferguson Ave., St. Louis, MO 63133, USA  
**Office Facility:** 1400 Ferguson Ave., St. Louis, MO 63133, USA

**Product Type:** Audio Amplifier

**Complies with the following Standards:**

**Safety:** EN60065, E60065, C22.2, UL6500 and/or UL813  
**EMC:** Directive 89/336/EEC, EN55103, EN55013, EN61000, and/or FCC 47CFR 15B cIA

Supplementary information provided by:  
SLM Electronics - R & D Engineering  
1901 Congressional Drive, St Louis, MO 63146, USA  
Tel.: 314-569-0141, Fax: 314-569-0175

# CRATE **BT25/BT50** Bass Amplifier

## The Front Panel:

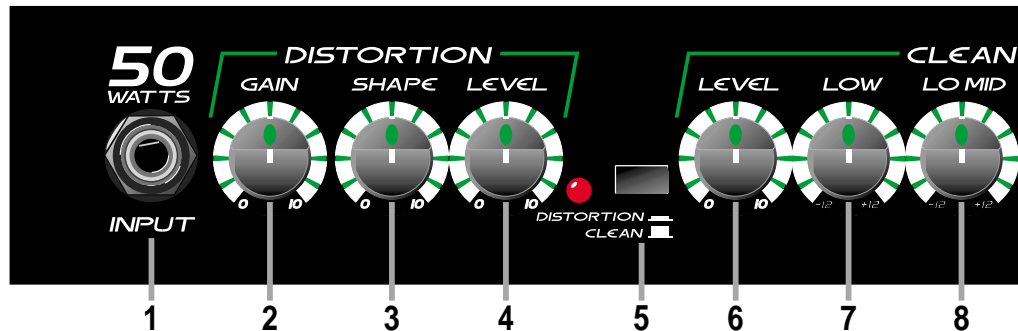

- 1. INPUT:** Use this 1/4" jack to connect your bass to the amplifier by means of a shielded instrument cable.
  - 2. GAIN:** Use this control to adjust the amount of distortion for the Distortion channel. As you rotate the control clockwise the amount of distortion increases.
  - 3. SHAPE:** Use this control to adjust the tone of the Distortion channel, from a studio "V"-shaped tone to a more "live," more present sound.
  - 4. LEVEL:** Use this control to adjust the output level of the Distortion channel.
  - 5. CHANNEL SWITCH:** Use this switch to select either channel. With the switch in the out position, the Clean channel is selected. When the switch is depressed, the Distortion channel is selected. The adjacent LED illuminates when the Distortion channel is selected. **NOTE:** When using a footswitch: when this switch is depressed, the footswitch switches between the Distortion channel and the Clean channel; when this button is in the out position, the Clean channel is always active, and the footswitch turns the Distortion channel on and off, allowing you a blend of both channels.
  - 6. LEVEL:** Use this control to adjust the output level of the Clean channel, and as part of the Octave level control (see #11).
- NOTE: The BT25/BT50 employs an internal noise gate to keep residual noise to a minimum. Regardless of which channel is selected, the Clean channel's Level control (#6) must be turned up above "0" in order for the noise gate to trigger.*
- 7. LOW:** Use this control to adjust the low frequency output of the Clean channel.
  - 8. LOW MID:** Use this control to adjust the lower-midrange frequency output of the Clean channel.
  - 9. HIGH MID:** Use this control to adjust the upper-midrange frequency output of the Clean channel.
  - 10. HIGH:** Use this control to adjust the high frequency output of the Clean channel.
  - 11. OCTAVE:** The BT25/BT50 features internal circuitry which creates a second signal which is one octave lower than the input signal. Use this control in conjunction with the Clean channel's Level control (#6) to adjust the level of the octave signal.
  - 12. MASTER:** Use this control to adjust the overall output level of the amplifier.

# CRATE **BT25/BT50** Bass Amplifier

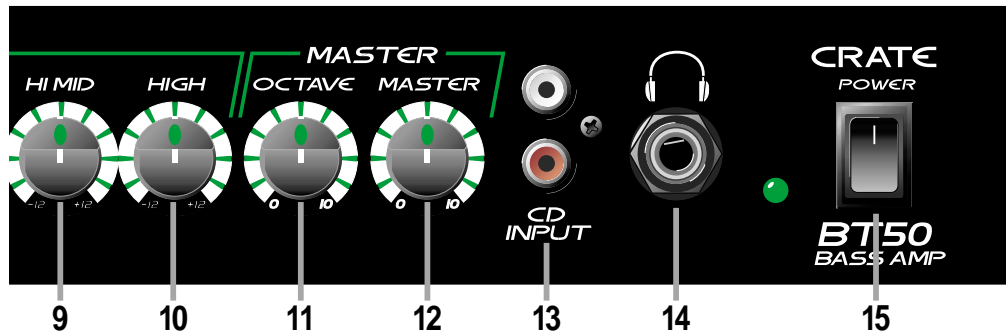

**13. CD INPUT:** Use these RCA jacks to connect the line level (or headphones) output of a CD player, tape deck or rhythm machine to the amplifier. The signal level from these jacks is adjusted by the Master control (#12). If the signal from the source connected to these jacks is too strong, use the output level control on the source to adjust the signal to obtain the proper level for a good mix.

**14. HEADPHONES:** Use this jack to listen to the amplifier through a pair of stereo headphones. The internal speaker is disconnected when the headphones jack is used.

**CAUTION:** To avoid possible damage to your hearing, do not use headphones for extended periods of time at extremely loud listening levels.

**15. POWER:** Use this switch to turn the amplifier on and off. The adjacent LED illuminates when the amplifier is turned on.

**16. ELECTRONIC TUNER (top panel):** This active electronic tuner is on whenever the amplifier is turned on, allowing you constant, “real-time” tuning. The tuner is fully chromatic – use the flat and sharp indicators until the LED between them illuminates, indicating proper tuning.

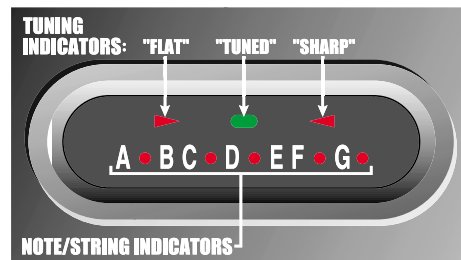

## **The Rear Panel (not shown):**

**17. AC LINE CORD:** The grounded power cord should only be plugged into a grounded power outlet that meets all applicable electrical codes and is compatible with the voltage, power, and frequency requirements stated on the rear panel. **Do not attempt to defeat the safety ground connection.**

**18. FOOTSWITCH:** Connect a two-button footswitch (such as the Crate CFP-2) here for remote control of the channel selection/“blend” (see #5) and octave on/off. (When the Channel Switch [#5] is depressed, the footswitch switches between the Clean channel and the Distortion channel; when the switch is in the out position, the Clean channel is always active, and the footswitch turns the Distortion channel on and off, allowing you a blend of both channels.)

**19. EXTERNAL SPEAKER:** Use this jack to connect the amplifier to an external speaker cabinet (BT25 = 4 ohms minimum, BT50 = 8 ohms minimum). The internal speaker is disconnected when the external speaker jack is used.

**Suggested Starting Settings:**

**Rock:**

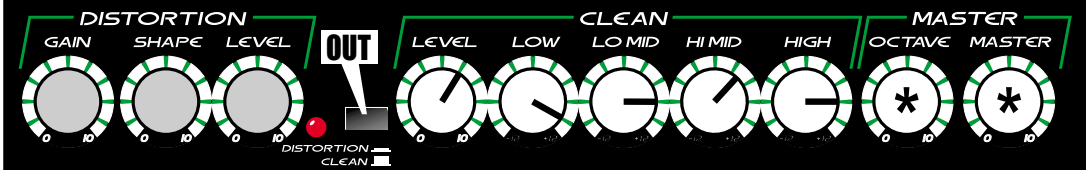

**Jazz:**

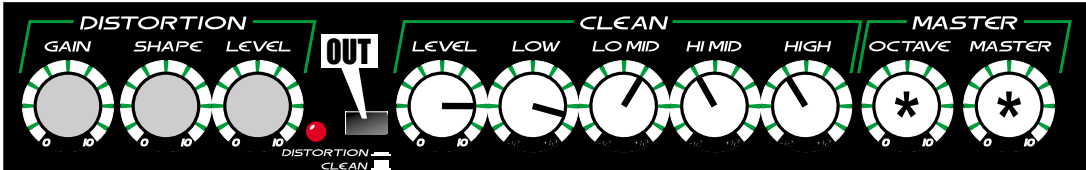

**Country:**

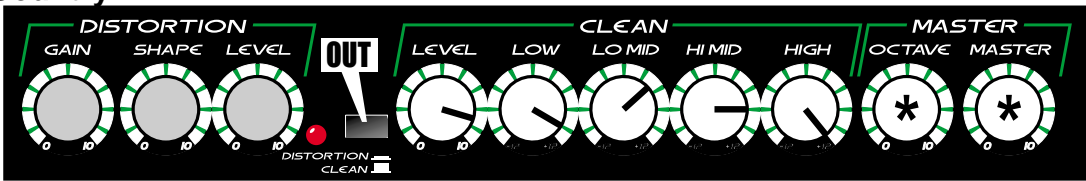

**Funk:**

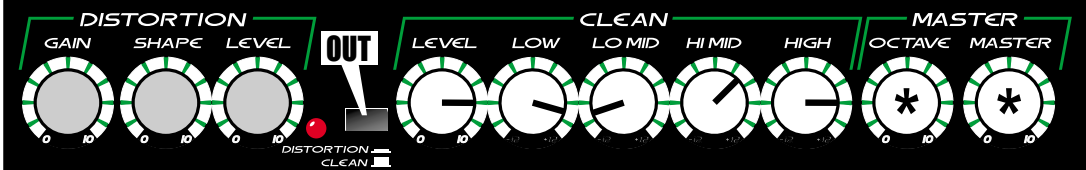

**Solo Fuzz:**

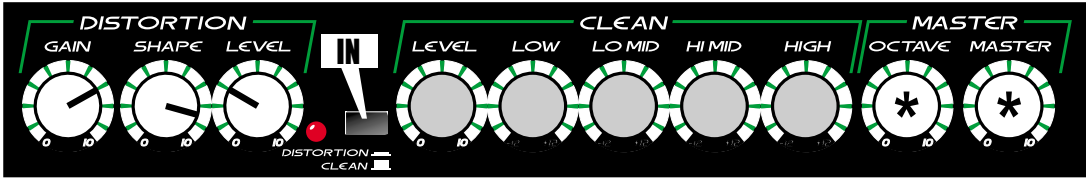

**Super Fat Fuzz:**

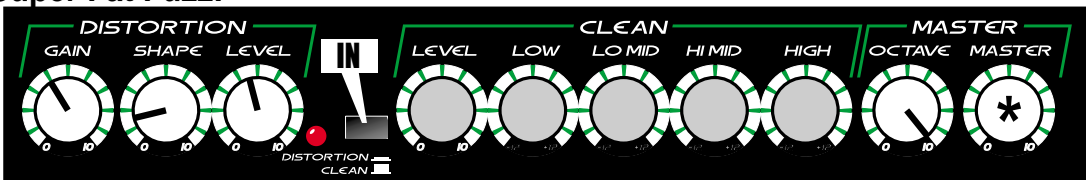

*\*As Needed*

# CRATE BT25/BT50 Bass Amplifier

## System Block Diagram:

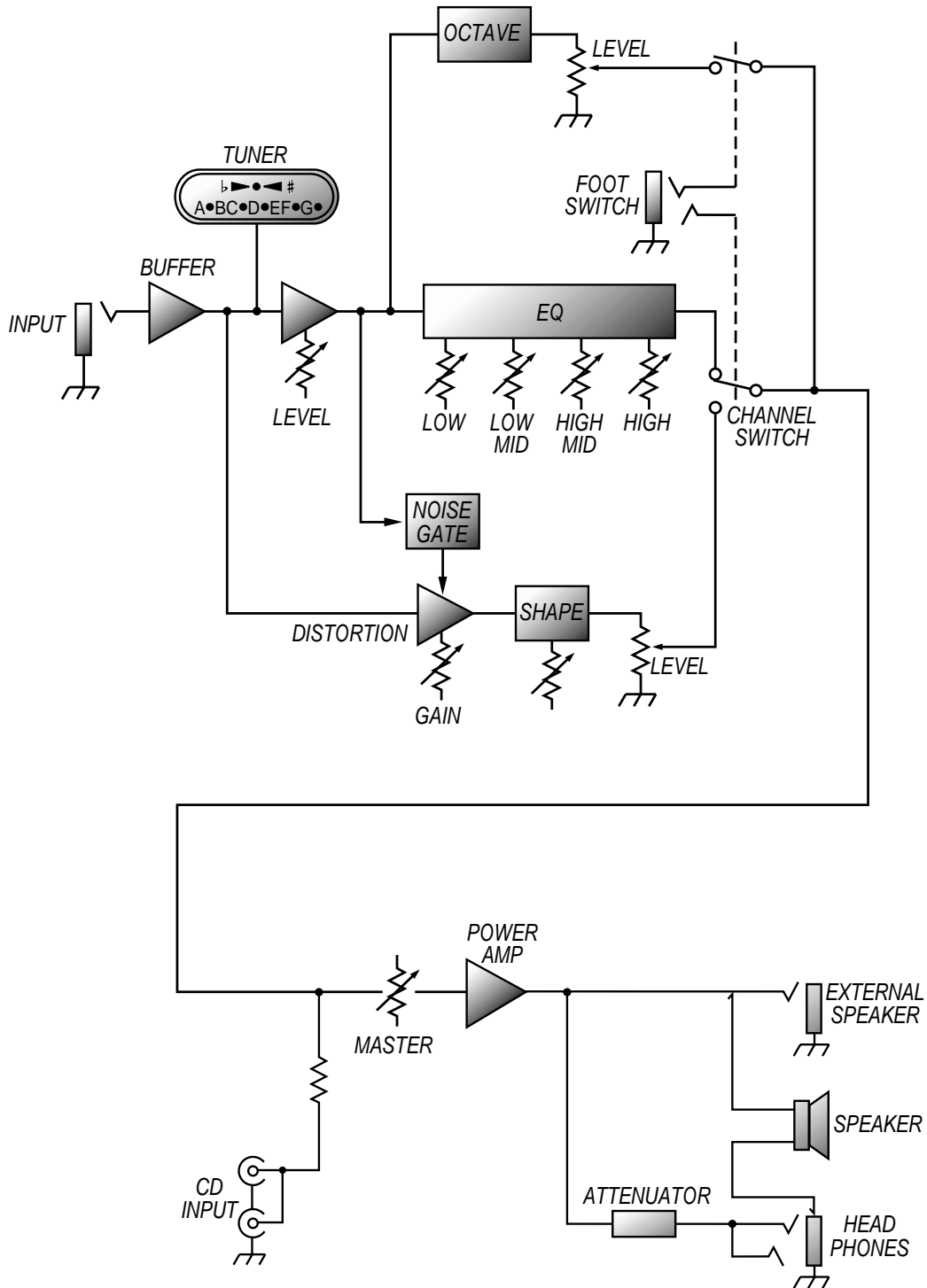

# CRATE **BT25/BT50** Bass Amplifier

## ***BT25/BT50 Technical Specifications:***

	<b>BT25</b>	<b>BT50</b>
Output Power Rating	25W RMS 2% THD, 4Ω, 120 VAC	50W RMS 2% THD, 4Ω, 120 VAC
Gain Distortion Channel	100dB	104dB
	Clean Channel 60dB	63dB
	CD Inputs 33dB	37dB
Tone Range	Low 21dB @ 50Hz	21dB @ 50Hz
	Lo Mid 23dB @ 150Hz	23dB @ 150Hz
	Hi Mid 18dB @ 1kHz	18dB @ 1kHz
	High 34dB @ 10kHz	34dB @ 10kHz
Signal to Noise Ratio	75dB	75dB
Input Impedance	220k ohms	220k ohms
Maximum Signal Accepted	15 volts peak-to-peak	15 volts peak-to-peak
Input Power Requirements	120 VAC, 60Hz, 45VA	120 VAC, 60Hz, 85VA
	100/115VAC, 50/60Hz, 45VA	100/115VAC, 50/60Hz, 85VA
	230VAC, 50/60Hz, 45VA	230VAC, 50/60Hz, 85VA
Internal Speaker	Size 10"	12"
	Type Crate Custom	Crate Custom
	Magnet 30 oz.	30 oz.
	Voice Coil 1"	1.5"
	RMS Rating 30 watts	50 watts
	Impedance 4 ohms	8 ohms
Size	18" H x 18" W x 12-1/2" D	21" H x 18" W x 14" D
Weight	37 lbs	46 lbs

*Specifications subject to change without notice*



[www.crateamps.com](http://www.crateamps.com)

