

CRATE

BT220





BASS AMPLIFIER



USER'S GUIDE

Table Of Contents:

Introduction	3
The Front Panel	4,5
The Rear Panel	5
Some Suggested Settings	6
System Block Diagram	7
Technical Specifications	back cover

 CAUTION RISK OF ELECTRIC SHOCK DO NOT OPEN	 PRECAUCION RIESGO DE CORRIENTAZO NO ABRA	 ATTENTION RISQUE D'ELECTROCUTION NE PAS OUVRIR
<small>WARNING: TO REDUCE THE RISK OF FIRE OR ELECTRIC SHOCK, DO NOT EXPOSE THIS APPARATUS TO RAIN OR MOISTURE. TO REDUCE THE RISK OF ELECTRIC SHOCK, DO NOT REMOVE COVER. NO USER-SERVICEABLE PARTS INSIDE. REFER SERVICING TO QUALIFIED SERVICE PERSONNEL.</small>	<small>PRECAUCION: PARA REDUCIR EL RIESGO DE INCENDIOS O DESCARGAS ELECTRICAS, NO PERMITA QUE ESTE APARATO QUEDE EXPUESTO A LA LLUVIA O LA HUMEDAD. PARA DISMINUIR EL RIESGO DE CORRIENTAZO, NO ABRA LA CUBIERTA. NO HAY PIEZAS ADETRON QUE EL USUARIO PUEDO REPARAR DEJE TODO MANTENIMIENTO A LOS TECNICOS CALIFICADOS.</small>	<small>ATTENTION: PROTÉGEZ CET APPAREIL DE LA PLUIE ET DE L'HUMIDITÉ AFIN D'ÉVITER TOUT RISQUE D'INCENDIE OU D'ÉLECTROCUTION. POUR RÉDUIRE D'ÉLECTROCUTION NE PAS ENLEVER LE COUVERCLE. AUCUNE PIÈCE INTERNE N'EST RÉPARABLE PAR L'UTILISATEUR. POUR TOUTE RÉPARATION, S'ADRESSEZ À UN TECHNICIEN QUALIFIÉ.</small>
IMPORTANT SAFETY INSTRUCTIONS		
<ul style="list-style-type: none"> • READ, FOLLOW, HEED, AND KEEP ALL INSTRUCTIONS AND WARNINGS. • DO NOT OPERATE NEAR ANY HEAT SOURCE AND DO NOT BLOCK ANY VENTILATION OPENINGS ON THIS APPARATUS. FOR PROPER OPERATION, THIS UNIT REQUIRES 3" (75mm) OF WELL VENTILATED SPACE AROUND HEATSINKS AND OTHER AIR FLOW PROVISIONS IN THE CABINET. • DO NOT USE THIS APPARATUS NEAR SPLASHING, FALLING, SPRAYING, OR STANDING LIQUIDS. • CLEAN ONLY WITH LINT-FREE DAMP CLOTH AND DO NOT USE CLEANING AGENTS. • ONLY CONNECT POWER CORD TO A POLARIZED, SAFETY GROUNDED OUTLET WIRED TO CURRENT ELECTRICAL CODES AND COMPATIBLE WITH VOLTAGE, POWER, AND FREQUENCY REQUIREMENTS STATED ON THE REAR PANEL OF THE APPARATUS. • PROTECT THE POWER CORD FROM DAMAGE DUE TO BEING WALKED ON, PINCHED, OR STRAINED. • UNPLUG THE APPARATUS DURING LIGHTNING STORMS OR WHEN UNUSED FOR LONG PERIODS OF TIME. • ONLY USE ATTACHMENTS, ACCESSORIES, STANDS, OR BRACKETS SPECIFIED BY THE MANUFACTURER FOR SAFE OPERATION AND TO AVOID INJURY. • WARNING: TO REDUCE THE RISK OF ELECTRIC SHOCK OR FIRE, DO NOT EXPOSE THIS UNIT TO RAIN OR MOISTURE.. • SERVICE MUST BE PERFORMED BY QUALIFIED PERSONNEL. • OUR AMPLIFIERS ARE CAPABLE OF PRODUCING HIGH SOUND PRESSURE LEVELS. CONTINUED EXPOSURE TO HIGH SOUND PRESSURE LEVELS CAN CAUSE PERMANENT HEARING IMPAIRMENT OR LOSS. USER CAUTION IS ADVISED AND EAR PROTECTION IS RECOMMENDED IF UNIT IS OPERATED AT HIGH VOLUME. 		
<small>EXPLANATION OF GRAPHICAL SYMBOLS: EXPLICACION DE SIMBOLOS GRAFICOS: EXPLICATION DES SYMBOLES GRAPHIQUES:</small>	 =	<small>"DANGEROUS VOLTAGE" "VOLTAJE PELIGROSO" "DANGER HAUTE TENSION"</small>
	 =	<small>"IT IS NECESSARY FOR THE USER TO REFER TO THE INSTRUCTION MANUAL" "ES NECESARIO QUE EL USUARIO SE REFIERA AL MANUAL DE INSTRUCCIONES." "REFERREZ-VOUS AU MANUAL D'UTILISATION"</small>

CRATE *BT220* Bass Amplifier

Congratulations!

You are now the proud owner of the Crate BT220 Bass Amplifier. The BT220 features two different channels: a distortion channel, featuring Crate's exclusive Shape control for quick and easy access to the tone you need, and a clean channel with a four-band rotary EQ. Another unique and valuable feature of this amplifier is the Octave control. This feature electronically creates a second signal that is one octave lower than the original signal. An active electronic tuner, conveniently located on top of the amplifier, allows you to get in tune and stay in tune "on the fly." The Mute switch allows you to tune in silence without changing the channel Level controls. A built-in Limiter keeps your sound clean even at full output power levels, and front panel jacks are provided for connecting a CD player and a pair of headphones, thereby optimizing your practice time.

Like all Crate products, your BT220 is designed by musicians and built using only the best components. Extensive testing at the hands (and ears) of skilled technicians and musicians insures you that this amplifier is the absolute best it can be.

In order to get the most out of your new bass amp, we urge you to check out the information in this manual before you begin playing.

And ***thank you*** for choosing Crate.

Declaration Of Conformity

#30, Effective 01-01-2001

Manufacturer's Name:	SLM Electronics
Production Facility:	1901 Congressional Drive, St. Louis, MO 63146, USA
Production Facility:	700 Hwy 202 W, Yellville, AR 72687, USA
Shipping Facility:	1400 Ferguson Ave., St. Louis, MO 63133, USA
Office Facility:	1400 Ferguson Ave., St. Louis, MO 63133, USA

Product Type: Audio Amplifier

Complies with the following Standards:

Safety:	EN60065, E60065, C22.2, UL6500 and/or UL813
EMC:	Directive 89/336/EEC, EN55103, EN55013, EN61000, and/or FCC 47CFR 15B c1A

Supplementary information provided by:
SLM Electronics - R & D Engineering
1901 Congressional Drive, St Louis, MO 63146, USA
Tel.: 314-569-0141, Fax: 314-569-0175

CRATE **BT220** Bass Amplifier

The Front Panel:

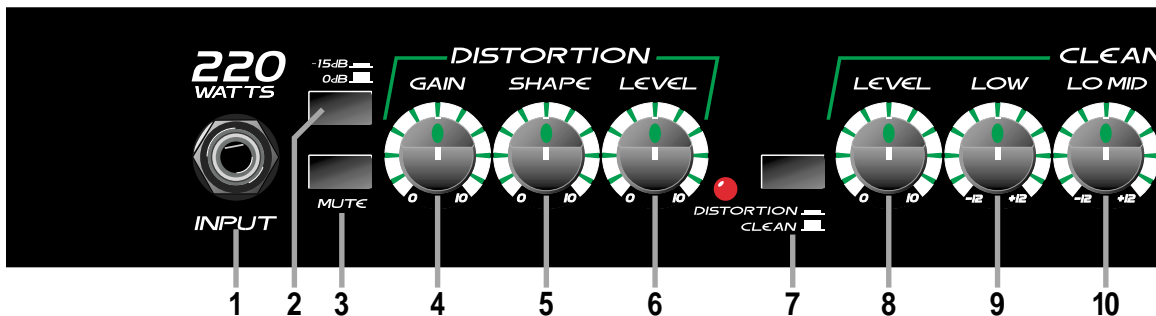

1. **INPUT:** Use this 1/4" jack to connect your bass to the amplifier by means of a shielded instrument cable.
2. **-15dB/0dB:** Use this switch to match the output signal level of your instrument to the amplifier. If your instrument has standard pickups, setting the switch to the 0dB position (switch in the out position) should yield the best results. If your bass has active electronics or high output pickups, set the switch to the -15dB position (switch depressed).
3. **MUTE:** This switch, when depressed, interrupts the signal prior to the power amplifier, allowing you to tune your instrument in silence.
4. **GAIN:** Use this control to adjust the amount of distortion for the Distortion channel. As you rotate the control clockwise the amount of distortion increases.
NOTE: The BT100 employs an internal noise gate on the Distortion channel to keep residual noise to a minimum. The Clean channel's Level control (#8) must be turned up above "0" in order for the noise gate to trigger properly. The Gain control (#4) and input signal level also affect the noise gate.
5. **SHAPE:** Use this control to adjust the tone of the Distortion channel, from a studio "V"-shaped tone to a more "live," more present sound.
6. **LEVEL:** Use this control to adjust the output level of the Distortion channel.
7. **CHANNEL SWITCH:** Use this switch to select either channel. With the switch in the out position, the Clean channel is selected. When the switch is depressed, the Distortion channel is selected. The adjacent LED illuminates when the Distortion channel is selected. **NOTE:** When using a footswitch: when this switch is depressed, the footswitch switches between the Distortion channel and the Clean channel; when this button is in the out position, the Clean channel is always active, and the footswitch turns the Distortion channel on and off, allowing you a blend of both channels.
8. **LEVEL:** Use this control to adjust the output level of the Clean channel, and as part of the Octave level control (see #13).
9. **LOW:** Use this control to adjust the low frequency output of the Clean channel.
10. **LOW MID:** Use this control to adjust the lower-midrange frequency output of the Clean channel.
11. **HIGH MID:** Use this control to adjust the upper-midrange frequency output of the Clean channel.
12. **HIGH:** Use this control to adjust the high frequency output of the Clean channel.
13. **OCTAVE:** The BT100 features internal circuitry which creates a second signal which is one octave lower than the input signal. Use this control in conjunction with the Clean channel's Level control (#8) to adjust the level of the octave signal.
14. **MASTER:** Use this control to adjust the overall output level of the amplifier.
15. **LIMIT LED:** This LED illuminates when the internal limiting circuit is active. Occasional flashing during playing is normal. If the Limit LED remains illuminated, reduce the output level of the amplifier until the LED flashes.
16. **CD INPUT:** Use these RCA jacks to connect the line level (or headphones) output of a CD player, tape deck or rhythm machine to the amplifier. The signal level from these jacks is adjusted by the Master control (#14). If the signal from the source connected to these jacks is too strong, use the output level control on the source to adjust the signal to obtain the proper level for a good mix.\

CRATE BT220 Bass Amplifier

The Front Panel:

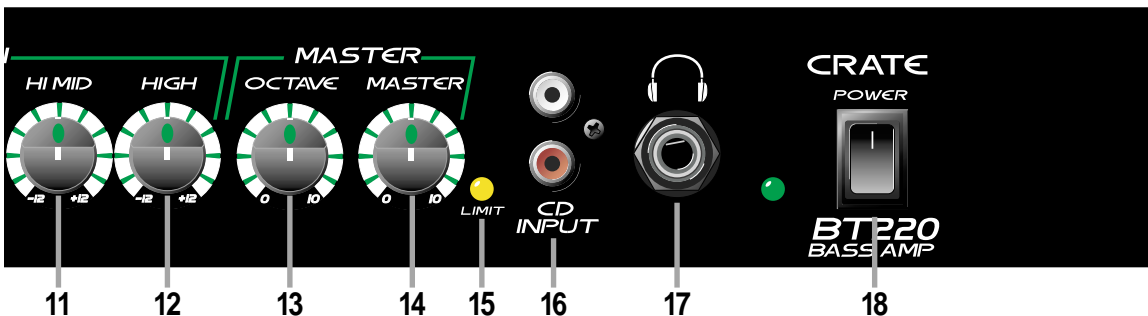

17. HEADPHONES: Use this jack to listen to the amplifier through a pair of stereo headphones. The internal speaker is disconnected when the headphones jack is used. **To avoid possible damage to your hearing, do not use headphones for extended periods of time at extremely loud listening levels.**

18. POWER: Use this switch to turn the amplifier on and off. The adjacent LED illuminates when the amplifier is turned on.

19. ELECTRONIC TUNER (top panel, not shown): This active electronic tuner is on whenever the amplifier is turned on, allowing you constant, "real-time" tuning. The tuner is fully chromatic – use the flat and sharp indicators until the LED between them illuminates, indicating proper tuning.

The Rear Panel:

20. AC LINE CORD (not shown): The grounded power cord should only be plugged into a grounded power outlet that meets all applicable electrical codes and is compatible with the voltage, power, and frequency requirements stated on the rear panel. **Do not attempt to defeat the safety ground connection.**

21. EXTERNAL SPEAKER: Use this jack to connect the amplifier to an external speaker cabinet. This jack is wired in series with the internal speaker, which remains active when this jack is used. A 4 ohm external speaker cabinet is recommended.

22. FOOTSWITCH: Connect a two-button footswitch (such as the Crate CFS-2) here for remote control of the channel selection/"blend" (see #7) and octave on/off. (When the Channel Switch [#7] is depressed, the footswitch switches between the Clean channel and the Distortion channel; when the switch is in the out position, the Clean channel is always active, and the footswitch turns the Distortion channel on and off, allowing you a blend of both channels.)

23. EFFECTS LOOP SEND: Use this jack to connect an external signal processor to the amplifier by means of a shielded signal cable. Connect the other end of this cable to the input jack of the external processor.

24. EFFECTS LOOP RETURN: Use this jack to connect an external signal processor to the amplifier by means of a shielded signal cable. Connect the other end of this cable to the output jack of the external processor.

25. BALANCED LINE OUT: Use this XLR jack to send a balanced line level signal to an external power amplifier, mixing board, or recording console.

26. PRE/POST: Use this switch to determine whether the Balanced Line Out signal is Post-EQ (switch depressed) or Pre-EQ (switch in the out position).

27. GROUND LIFT: This switch, when depressed, lifts the ground connection at the Balanced Line Out jack (#25). This may help reduce hum in the Balanced Line Out signal.

28. VOLUME: Use this control to adjust the signal level at the Balanced Line Out jack (#25).

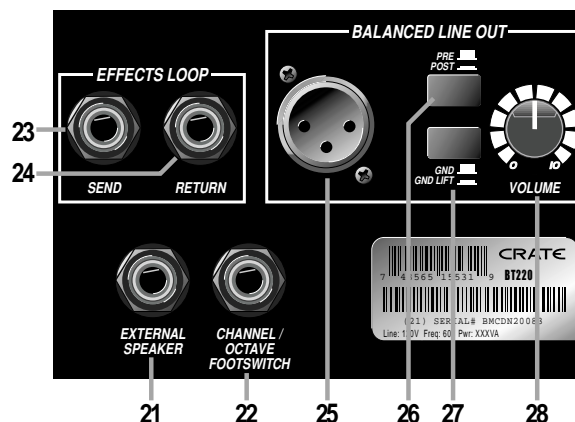

CRATE BT220 Bass Amplifier

Suggested Starting Settings:

Rock:



Jazz:

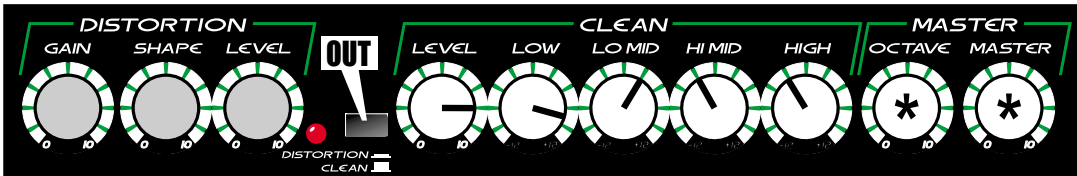

Country:

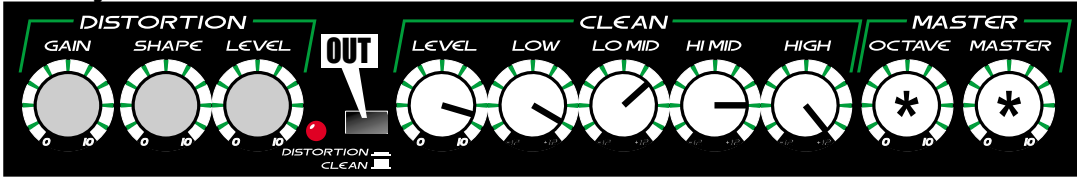

Funk:

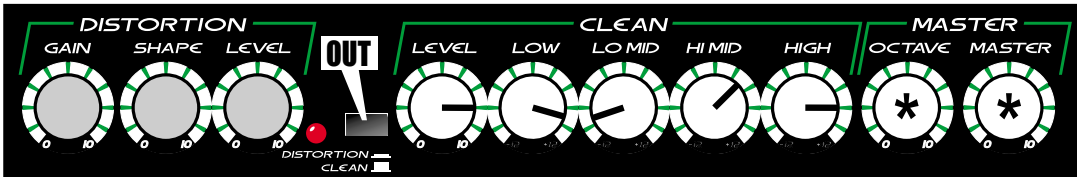

Solo Fuzz:

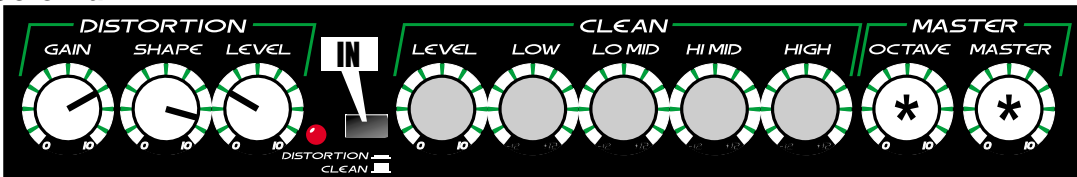

Super Fat Fuzz:

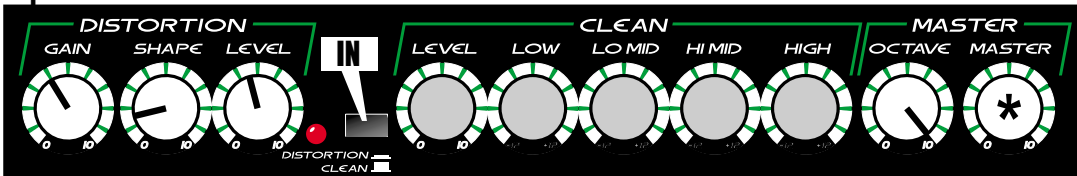

*As Needed

CRATE BT220 Bass Amplifier

System Block Diagram:

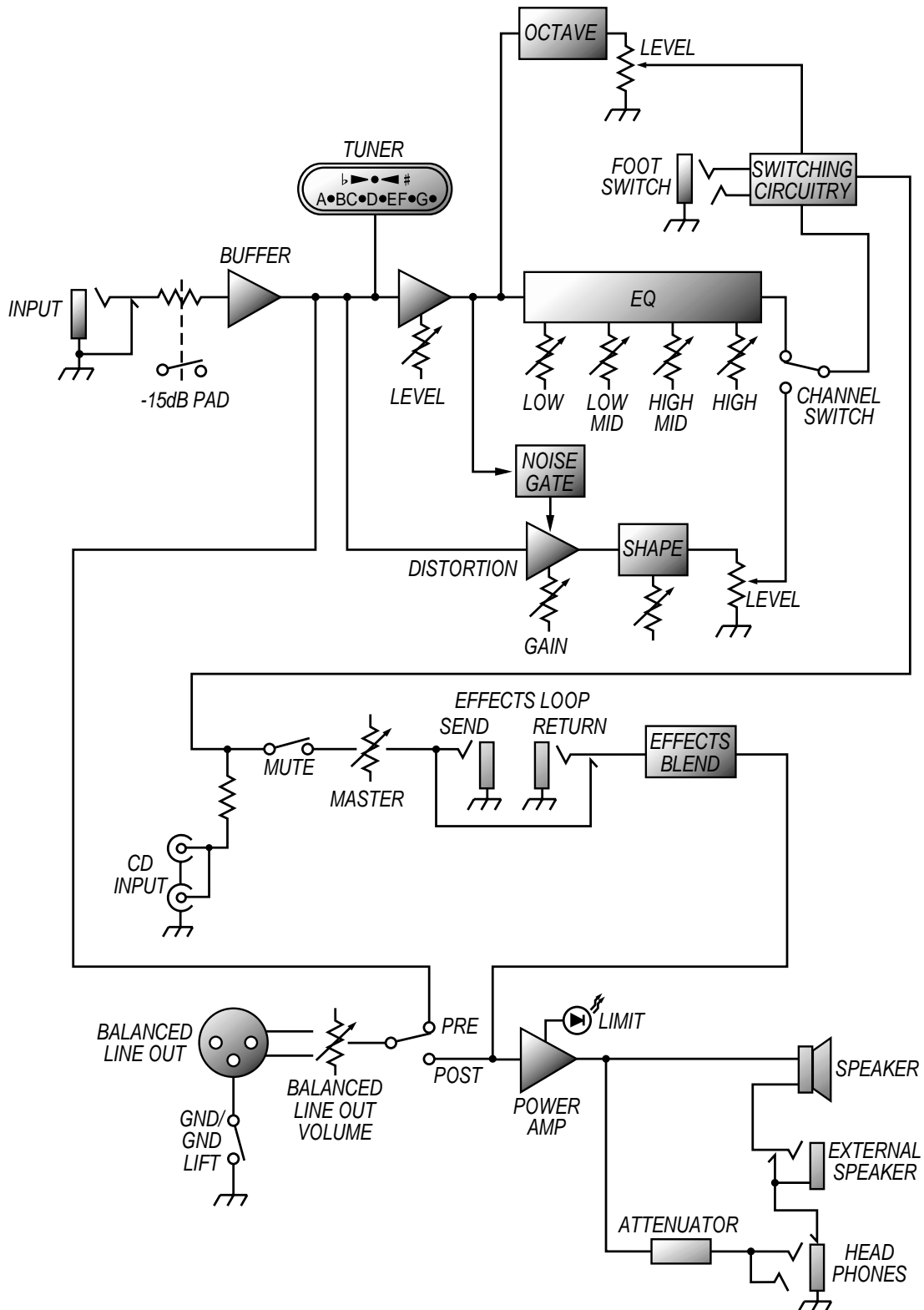

CRATE *BT220* Bass Amplifier

BT220 Technical Specifications:

Output Power Rating		220W RMS 2% THD, 4Ω, 120 VAC
Gain	Distortion Channel	103dB
	Clean Channel	61dB
	CD Inputs	33dB
Tone Range	Low	20dB @ 50Hz
	Lo Mid	24dB @ 150Hz
	Hi Mid	18dB @ 1kHz
	High	32dB @ 10kHz
Signal to Noise Ratio		65dB below full power, tones flat, gain and level @ "10"
Input Impedance		220k ohms
Maximum Input Signal Level Accepted		15 volts peak-to-peak
Balanced Line Out Jack		2 volts peak-to-peak @ full rated power w/600 ohm load
Internal Speaker	Size	15"
	Type	Crate Custom Cast Frame
	Magnet	66 oz.
	Voice Coil	2.5"
	RMS Rating	250 watts
	Impedance	4 ohms
Input Power Requirements		120 VAC, 60Hz, 250VA
		100/115VAC, 50/60Hz, 250VA
		230VAC, 50/60Hz, 250VA
Size		24-1/2" H* x 24-1/2" W x 16-1/2" D
Weight		87 lbs

*without casters

Specifications subject to change without notice



www.crateamps.com



©2003 ST. LOUIS MUSIC, 1400 FERGUSON, ST. LOUIS, MO. 63133
47-349-01 • 012904

